



saobraćajna signalizacija i oprema



www.signal.co.rs

Proces proizvodnje



Iz table lima iseca se oblik znaka



Savijanje ivice znaka



Mašinsko nitovanje šelni



Komora za farbanje poleđine znaka



Sitoštampa



Apliciranje pripravljene folije na limenu podlogu

Proizvodnja saobraćajnih znakova

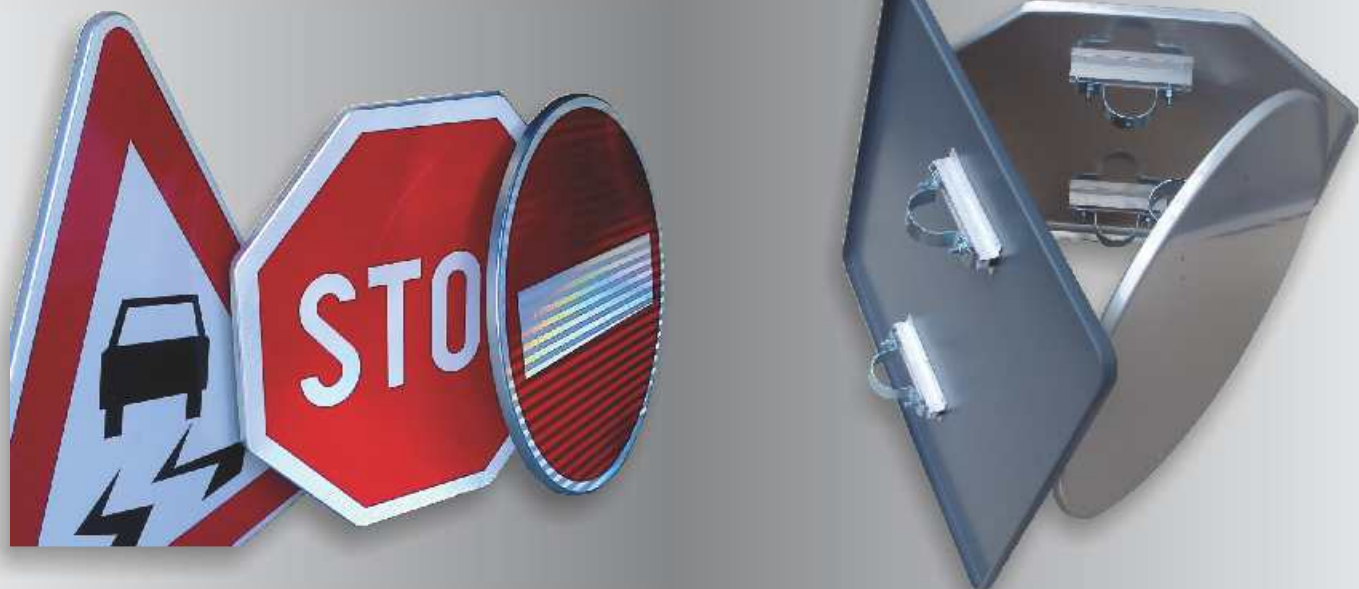

Koristeći najkvalitetnije materijale u proizvodnji, od reflektujuće folije do lima za podloge, postiže se kvalitet proizvoda ravan kvalitetu evropskih proizvođača.



Nova tehnologija u proizvodnji limenih podloga, nova CNC mašina za kontinuirano savijanje ruba znaka po celom obodu. Znakovi sa povijenom ivicom mogu biti izrađeni od aluminijumskog i od pocinkovanog lima.



Ovom tehnologijom je moguće proizvesti sve oblike saobraćajnih znakova različitih veličina, od 250 mm pa do 1300 mm. Pozadina limene podloge može biti farbana ili matirana i ostaveljna u prirodnoj boji lima.

Šelne



pocinkovana šelna

pocinkovana šelna
zanitovana za poledinu
saobraćajnog znaka



pocinkovana šelna - farbana



aluminijumski profil
zanitovan za poledinu znaka



drugi deo šelne



šelna od Al profila

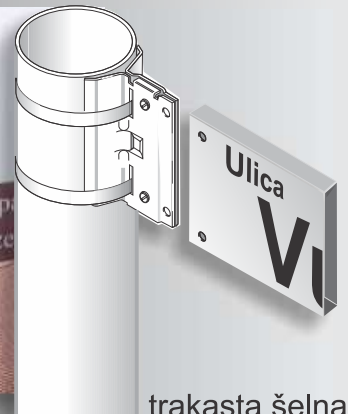

trakasta šelna

Šelne od Al profila za
postavljanje dva znaka na isti
stub 'leđa u leđa'



specijalna šelna za stub od 2"



Podloge saobraćajnih znakova



GS-S

Podloga znaka od pocinkovanog lima sa pocinkovanom šelnom - neofarban



GS-SC

Podloga znaka od pocinkovanog lima sa pocinkovanom šelnom - siva pozadina



AL-S

Al podloga znaka sa pocinkovanom šelnom - pozadina u prirodnoj boji aluminijuma



AL-SC

Al znak sa pocinkovanom šelnom - siva pozadina



AL-P

Al podloga znaka sa šelnom od Al profila - pozadina u prirodnoj boji aluminijuma



AL-PC

Al podloga znaka sa šelnom od Al profila - siva pozadina



AL-E

Aluminijumska podloga znaka sa šelnom od Al profila - eloksirano



Saobraćajni znakovi

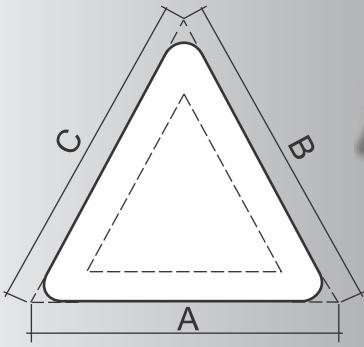

Standardne dimenzije: 600x600x600mm, 900x900x900mm, 1200x1200x1200mm

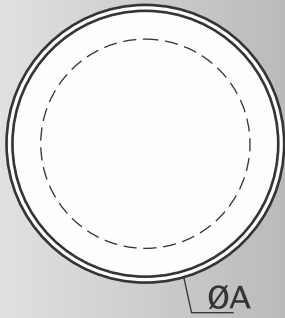

Standardne dimenzije: Ø400mm, Ø600mm, Ø900mm, Ø1200mm

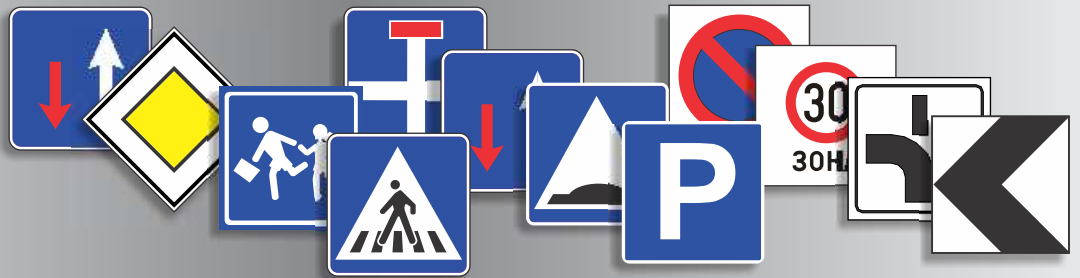
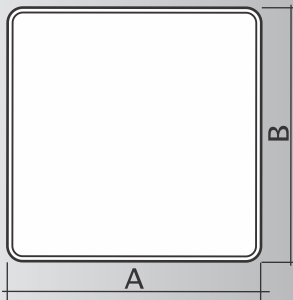

Standardne dimenzije: 400x400mm, 600x600mm, 900x900mm

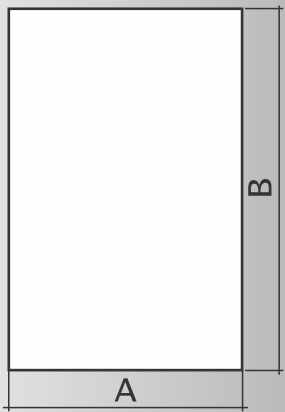

Standardne dimenzije: 400x600mm, 600x900mm, 900x1350mm



Saobraćajni znakova na fluorescentnoj pozadini



Žuto-zelena fluorescentna Diamond Grade folija



Žuta fluorescentna Diamond Grade folija



Izvozni program



Standardni proizvodni program za švajcarskog kupca

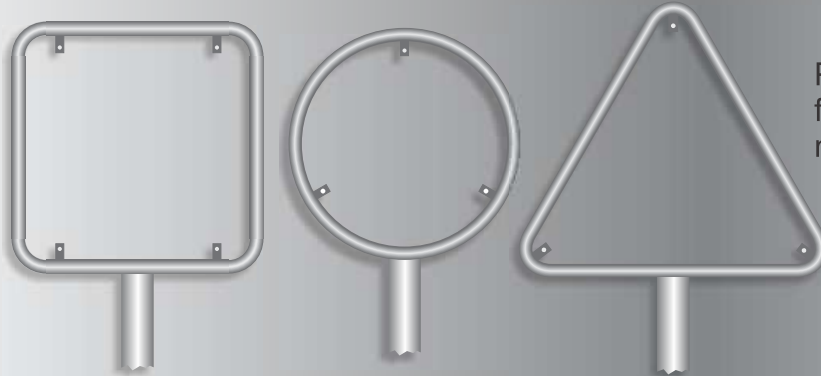

Podloga ovih znakova je ravan Al lim, farbane pozadine, predviđen za montiranje na ramove od pocinkovanih cevi



Specijalni znakovi, od kojih su neki nereflektujući na limu, ili štampani direktno na plastiku

Proizvodi za kupca iz Iraka



Proizvodnja i postavljanje saobraćajnih tabli

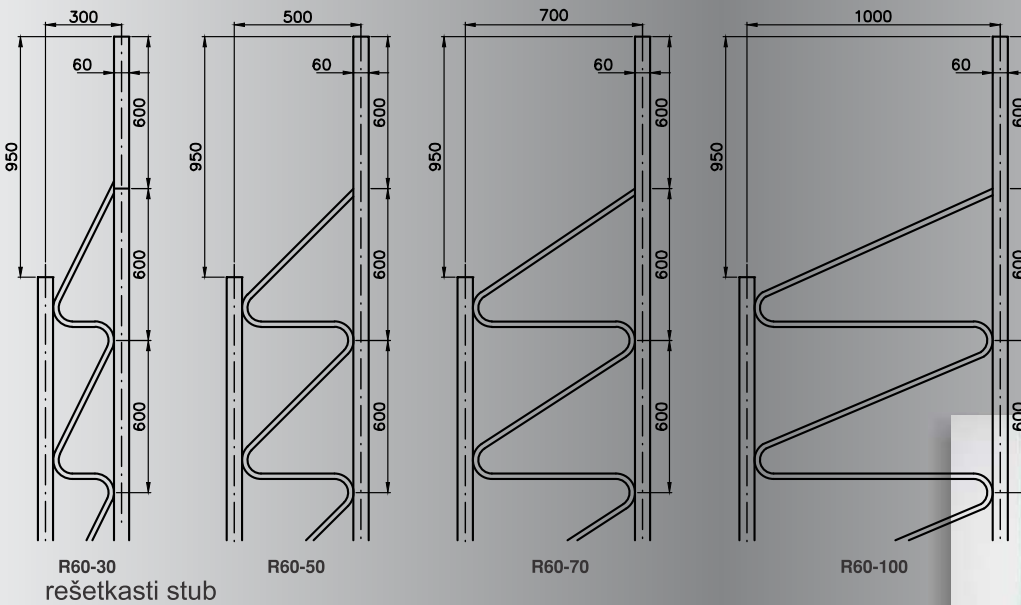
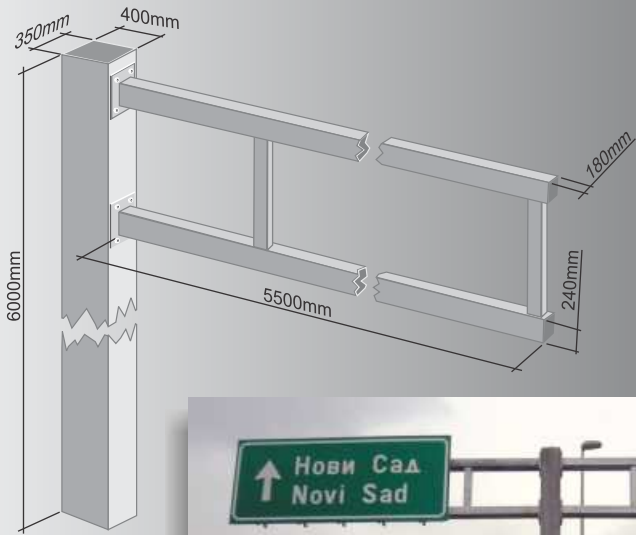

Turistička signalizacija

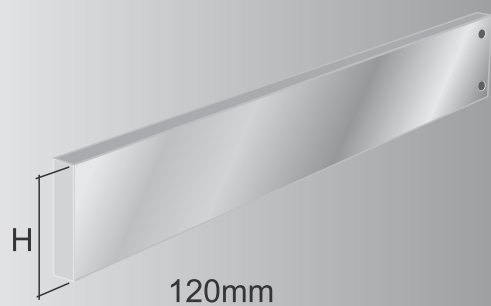

Al ekstrudirani profil
H=120mm or 130mm

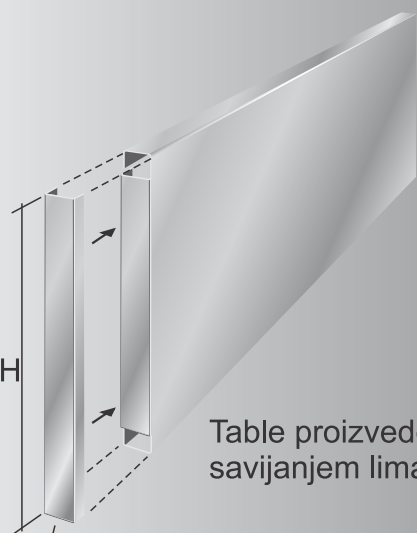

Table proizvedene savijanjem lima

H=300mm (najčešća dim. ali može biti po želji kupca)



Informativne table sa unutrašnjim osvetljenjem



Mobilna ograda



Mobilna 'rastegljiva' ograda
Maksimalna širina: 4000mm
Minimalna širina: 360mm
Visina: 940mm

Lagana, proizvedena od aluminijuma



Montažna barijera

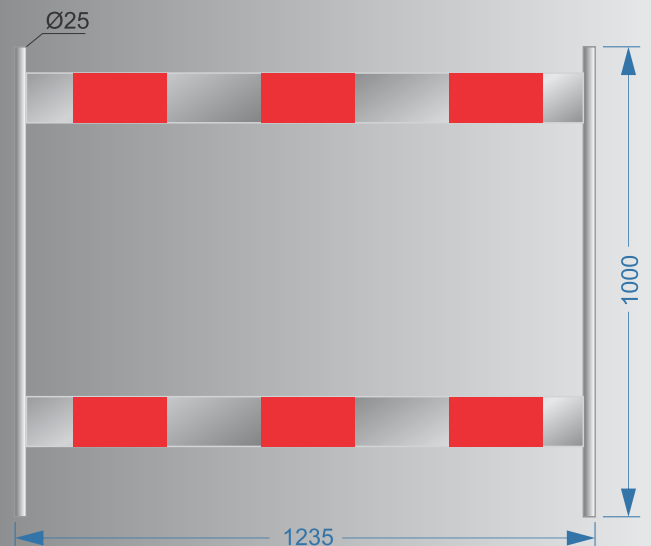

Saobraćajna oprema



Katadiopteri za ograde



Lisnati stubi

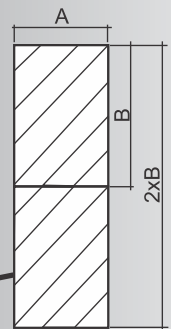
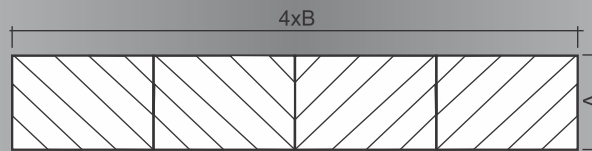

Ševron ploče

A	B
600	900

Tunelski delineatori



A
140



Saobraćajna oprema

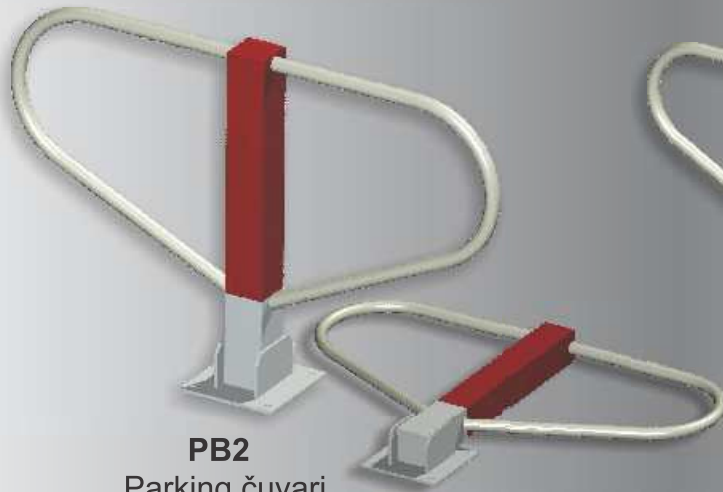

PB2
Parking čuvari

H	W
470mm	700mm

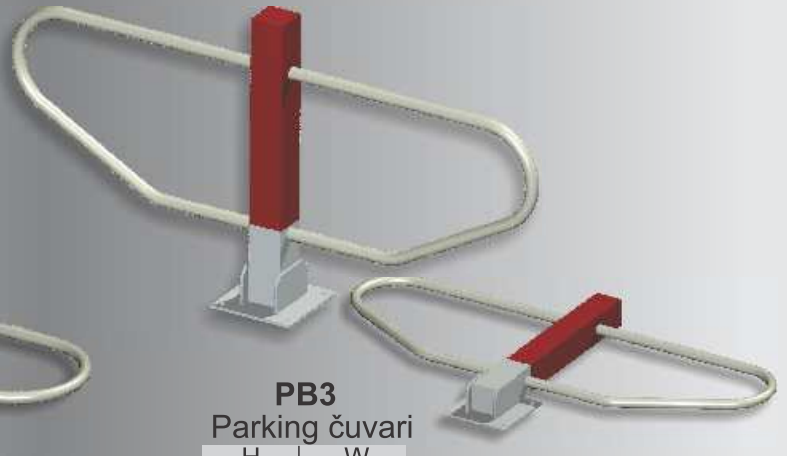

PB3
Parking čuvari

H	W
470mm	1000mm

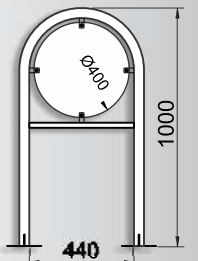

PS400

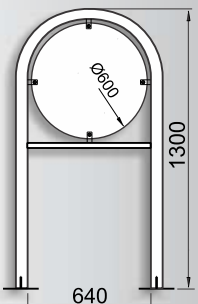

PS600



Znak i nosač
'Pešačka zona'

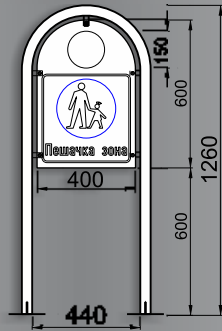

PZ400

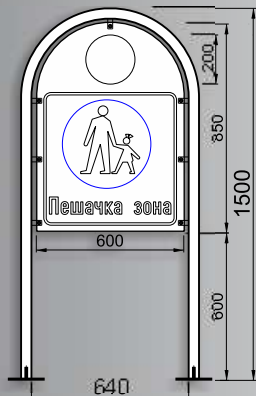

PZ600



Znak i nosač
'Pešačka zona'

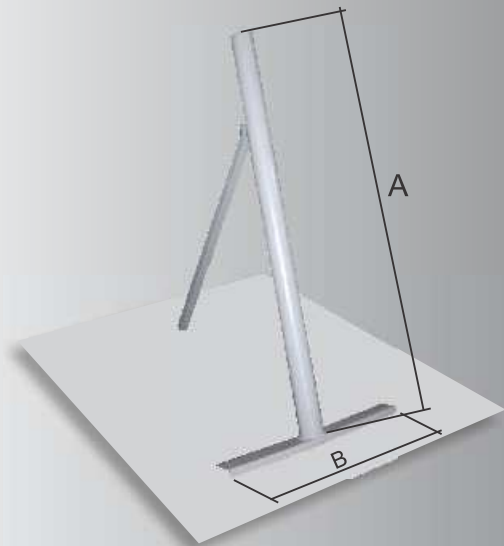

oslanjač za 1 znak

A	B
1000	500

oslanjač za 2 znaka

A	B
2000	900



Vertikalna signalizacija



Hofmann H25



Hofmann H25-4



Hofmann H11-1
Kompaktna mašina, korisna za male prostore



Ručno vođena mašina za hladnu plastiku



Ručno vođena mašina za
standardne putarske boje



Vertikalna signalizacija



Obeležavanje puteva svih kategorija



Obeležavanje prilaza školi ili drugim institucijama za decu



Zvučne trake



Postavljanje termoplastične oznake na asfalt



Mašina za demarkiranje



Trenutne izvozne destinacije



SRBIJA
25000 Sombor, Centrala 30
Tel./Fax: +381 25 422 542
428 459
420 470

office@signal.co.rs
www.signal.co.rs

